



**1994 - 2002 FORD 8-POSITION CHIP INSTALLATION INSTRUCTIONS**

**PART NUMBERS: QZ8PS73L, QZ8PS73LXXXX**



## **INTRODUCTION**

Thank you for your purchase of a Quadzilla product. We know you'll be more than satisfied with the increased performance our product provides. Be sure to tell your fellow diesel truck owners about Quadzilla.

This product may alter the technician's ability to use diagnostic equipment. Please remove this Quadzilla product when taking your truck into a service facility.

The installation of this product indicates the BUYER has read and understands this agreement and the **'DISCLAIMER OF LIABILITY'** agreement contained at the end of this document and accepts its terms and conditions.

**IMPORTANT: THIS IS A HIGH PERFORMANCE PRODUCT. USE AT YOUR OWN RISK.**

Before beginning the installation of your new 8 Position Chip, read these instructions in their entirety. Make sure you understand the steps and possess the skills required to install this product. If you have any questions regarding the installation please contact your dealer before starting the installation process.

When routing wires, pay special attention to avoid any moving, sharp, or hot engine components.

It is recommended to disconnect both batteries before installation.

**IMPORTANT: DO NOT INSTALL IF THE PGM CODES OF THIS PRODUCT AND YOUR TRUCK DO NOT MATCH.**



## SUPPLIED ITEMS:

### 8-POSITION CHIP/SWITCH / WIRES

---

8-POSITION CHIP

SWITCH WIRE

8 POSITION SWITCH

INSTALLATION INSTRUCTIONS

SWITCH KNOB

HEX WRENCH

SCOTCH-BRITE™ PAD

ALCOHOL WIPE

VINYL STICKER

## REQUIRED TOOLS:

SIDE CUTTERS

RAZOR BLADE OR KNIFE

1/2" WRENCH

10MM SOCKET/WRENCH

7MM SOCKET/ WRENCH

13MM SOCKET

2MM ALLEN WRENCH

DRILL

1/4" OR 3/8" RATCHET

3/8" DRILL BIT

9/16" DRILL BIT

1/8" DRILL BIT

## 8-POSITION CHIP POWER LEVELS\*\*

**SW01:** Stock

**SW05:** Daily Driving

**SW02:** High Idle

**SW06:** Performance

**SW03:** Tow1

**SW07:** Race

**SW04:** Tow2 (More HP)

**SW08:** Beast Mode

\*\* Power Levels will vary based on PCM code

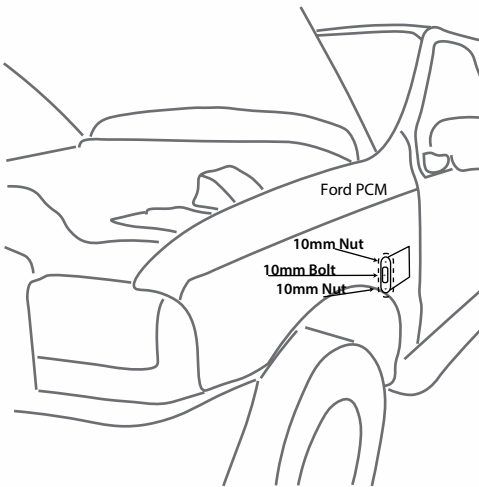

1994 to 1997 Ford 7.3L  
ECU location

1999 to 2003 Ford 7.3L  
ECU location

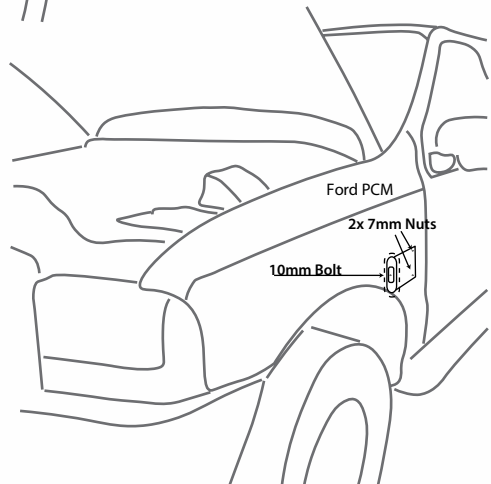



## 1994.5-1997 INSTALLATION INSTRUCTIONS

1. Disconnect both batteries.

2. Locate your PCM. All models will have the PCM on the firewall on the driver's side next to the outside wall of the truck. Refer to the example diagram on the previous page and to picture A-1.



3. Remove the wiring harness using a 10mm socket to unbolt the harness from the ECU.

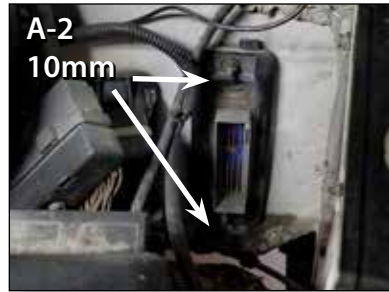

4. Remove the 10mm nuts on the top and bottom of the ECU mount and remove the gasket seal and mount that is placed around the ECU as shown in A-2. This gasket and mount can be difficult to remove the first time. The PCM code may be visible at this point using a mirror or camera. If the PCM code does not match or is not compatible with the PCM code of the device, stop the installation and contact Quadzilla or your local dealer for more information.

5. Loosen the fender well liner closest to the firewall. Remove the 8mm bolt securing the fender well to the frame. Loosen the fuse panel nuts with an 11mm socket; (they don't need to be removed completely). Remove the 7/32" outer fender well bolts on the half of the fender well liner closest to the firewall or driver's side door. Slide the PCM out of the socket.

5. Loosen the fender well liner closest to the firewall. Remove the 8mm bolt securing the fender well to the frame. Loosen the fuse panel nuts with an 11mm socket; (they don't need to be removed completely). Remove the 7/32" outer fender well bolts on the half of the fender well liner closest to the firewall or driver's side door. Slide the PCM out of the socket.

6. (Optional) – Remove the parking brake pedal by removing the 3 13mm nuts. After removing those nuts, you can swing the parking brake out of the way and view the hole where the PCM was located.

- 7.** Route the switch wire around the body pillar as shown in A-3, not through the hole the parking brake assembly uses. Run the switch wire out of the hole for the PCM in the firewall.

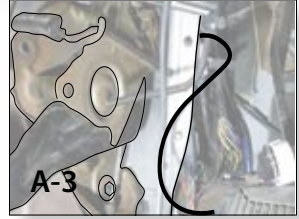

- 8.** Double check the PCM code to make sure that it is compatible with the purchased chip. If the codes do not match or you have questions, contact Quadzilla Power or your preferred dealer to ensure the compatibility of the chip.



- 9.** Remove the plastic cover on the back of the PCM to get access to the PCM's contacts for the chip. This cover is shown in A-4

- 1 0.** Thoroughly clean the contacts of all protective coatings on both sides of the circuit board as shown in A-5 and A-6. Some excess protective coating can be removed using a dull knife or a scraping tool. Be careful not to remove the actual pad and only the gel like covering. Use the included Scotch Brite™ pad to finish cleaning the pads. Make sure that the silver surface of the contacts has been thoroughly scuffed. It is preferable to have a small amount of the copper showing on the contacts. Most installation issues are a result of not having these contacts cleaned properly.



- 1 1.** Plug the wire into the chip and plug the chip into the PCM.

- 1 2.** Use the enclosed 4"x6" vinly sticker to cover the chip to hold it in place and to reduce the amount of dust that can be introduced into the PCM as shown in A-7.





- 1 3.** Carefully slide the PCM back into place in the enclosure making sure that the wire is not pinched or pulled.
- 1 4.** Replace the gasket seal and mount over the PCM and replace the 2 10mm nuts. See A-8.
- 1 5.** Replace the main wiring harness and reattach the wiring with the 10mm bolt.
- 1 6.** Replace the battery cables.
- 1 7.** Test the switch to make sure the installation is right – turn the key to the run position and make sure the wait to start turns on and back off again. With the switch in the 2nd or 3rd position depending on tuning, the truck should idle near 1100 RPMs. if he truck idles high near 1100RPMs, the switch is working. If there is no high idle in any position, remove the PCM and make sure the contacts are clean, then try again.



- 1 8.** Replace the parking brake and reapply the 3 10mm nuts. See A-9.
- 1 9.** Replace the fender well liner by re-attaching the 8MM bolt to the frame, tighten the two 10mm nuts and re-attach the removed 7/32" outside bolts. See A-10.



## 1999-2003 INSTALLATION INSTRUCTIONS

1. Disconnect both batteries.
2. Locate your PCM. All models will have the PCM on the firewall on the driver's side next to the outside wall of the truck. Refer to the example diagram on page 4 and A-11.
3. Remove the wiring harness using a 10mm socket to unbolt the harness from the PCM.
4. Remove the two 7mm bolts securing the PCM to the mount. On standard transmission vehicles it may be necessary to remove the full bracket mount of the PCM by removing the two 10mm bolts securing the bracket to the body and the firewall.
5. Double check the PCM code to make sure that it is compatible with the purchased chip. If the codes do not match or you have questions, contact Quadzilla Power or your preferred dealer to verify the compatibility of the chip.
6. Remove the plastic cover on the back of the PCM to get access to the PCM's contacts for the chip.
7. Thoroughly clean the contacts of all protective coatings on both sides of the circuit board. Some excess protective coating can be removed using a dull knife or a scraping tool. Be careful not to remove the actual pad and only the gel like covering. Use the included Scotch Brite™ pad to finish cleaning the pads. Make sure that the silver surface of the contacts has been thoroughly scuffed. It is preferable to have a small amount of the copper showing on the contacts. Most installation issues are a result of not having these contacts cleaned properly.







8. Drill a 3/8" hole in the black enclosure for the switch wire to pass through. Do not remove more of the plastic than necessary as it will aid in keeping the chip from moving once installed. Route the wire through the hole in the black plastic enclosure.

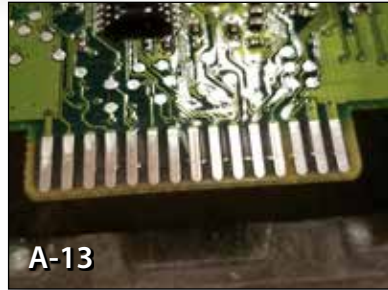

9. Plug the wire into the chip and plug the chip into the PCM as shown in A-14.

- 1 0. Use the enclosed 4"x6" vinyl sticker to cover the chip to hold it in place and to reduce the amount of dust that can be introduced into the PCM.



- 1 1. Carefully slide the PCM back into place in the enclosure making sure that the wire is not pinched or pulled.

- 1 2. Reapply the two 7mm bolts to hold the ECU in place. (Replace the two 10mm bolts if needed on the manual transmission vehicles).

- 1 3. Replace the main wiring harness and reattach the wiring with the 10mm bolt.



- 1 4. Replace the battery cables.

- 1 5. Test the switch to make sure the installation is right – turn the key to the run position and make sure the wait to start turns on and back off again. With the switch in the 2nd or 3rd position depending on tuning, the truck should idle near 1100 RPMs, if it idles high at 1100RPMs, the switch is working. If there is no high idle in any position, remove the PCM and make sure the contacts are clean, then try again.

## SWITCH INSTALLATION INSTRUCTIONS

1. Route the switch wire to your desired location for the switch.
2. Mark a location to drill a 3/8" hole for the switch to enter.
3. Mark a location to drill a 1/8" hole 3/8" center to center from the 3/8" hole for the locating lug as shown in A-15. Before drilling, test the alignment of the switch and wire to ensure the wire isn't kinked or bent drastically. If your switch has a flat side on the actuator, align the locating lug to point the opposite direction of where you want position 1 to be.
4. Drill the holes previously marked.
5. Apply the position sticker in the desired location.
6. Turn the switch all the way to the left in first position.
7. Remove the nut from the switch but leave the lock washer and stop ring in place, being careful not to let the stop ring out of position.

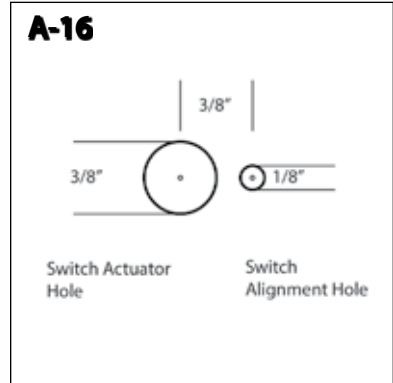

8. Put the switch through the 3/8" hole and align the alignment knob with the 1/8" hole. Tighten the nut onto the switch finger tight only.



9. Turn the actuator all the way to the left in the first position. Loosen the hex set screw in the knob to allow the knob to be placed over the actuator.
10. Align the indicator on the knob with the "1" on the sticker and then tighten the set screw down to keep it in place.
11. Secure any extra low hanging wire with the provided zip ties.
12. Enjoy the extra power!





## TECH SUPPORT

Please contact your dealer for all Tech Support prior to contacting Quadzilla Power. Your dealer should be able to provide you with any assistance you might need. If further assistance is needed, Quadzilla Power, LLC can be reached by the phone number or email address below. Any messages/emails received after 5:00 pm will be returned the next business day.

**801-872-5472**

**[TECH@QUADZILLAPOWER.COM](mailto:TECH@QUADZILLAPOWER.COM)**



Ask a question online:  
[www.quadzillapower.com/contact-support/](http://www.quadzillapower.com/contact-support/)

## HOURS OF OPERATION

Monday – Thursday  
8:00am – 5:30pm MST  
Friday  
8:00am -4:30pm MST

Quadzilla Power, LLC offers a 30-Day Money Back Guarantee for Electronic Modules returned in NEW CONDITION, as determined and verified by Seller. Quadzilla Power, LLC warrants that all Goods shall be free of substantive defects in material and workmanship for a period of one (1) year, unless otherwise stated in writing. Failure to register your product within 90 days of purchase will void the one (1) year unlimited mileage warranty. Any product returned for refund must be sent back to the dealer it was purchased from. Quadzilla Power, LLC does not refund the end user if product was not purchased direct. Please contact your dealer prior to returning products for refund.

An RMA # must accompany all returns and exchanges and must be written on the outside of the box and be visible by receiver or they will be refused. Returns and exchanges must also be shipped pre-paid or they will be refused.

Damage to any items occurred during shipping due to improper packaging is the responsibility of the customer. For any item not covered under WARRANTY the customer is responsible for all charges that includes but is not limited to: repair work, replacement of parts, replacement of items, and shipping back to customer. Quadzilla is not responsible for any damage or modification done to any items while in customer's possession. If items are not covered under WARRANTY the customer will be charged any and all expense to repair/replace any items damaged or modified. This does include improper care and installation.



PLEASE CONTACT YOUR DEALER FOR ADDITIONAL PRODUCTS AVAILABLE FOR YOUR VEHICLE.

COMING SOON: DEDICATED TOUCH SCREEN MONITOR/CONTROLLER WITH SUPPORT FOR MULTIPLE PERIPHERAL GAUGES AND OTHER ACCESSORIES ...



1994 - 2002 FORD 7.3L 8-POSITION CHIP

## WARRANTY

All QUADZILLA Performance Modules, Tuners, and units are covered by a one year unlimited mileage warranty.

### WHAT IS WARRANTED:

Any Performance Modules/Tuners Diesel Performance Enhancement Software specified for and Cummins, Powerstroke, and, Duramax diesel engines, except those units sold exclusively for racing and/ or off-road use.

### WHO IS COVERED BY WARRANTY:

The original purchaser of a Performance Modules/Tuners who has completed the required warranty registration and provided proper proof of the original retail purchase and all other required information.

### WHAT IS NOT WARRANTED:

Any Performance Modules/Tuners used for any type of racing or competition, any off-road use, custom or modified applications, any non-legal or industrial applications. (These units are covered by a one year unlimited mileage warranty for both Software and Hardware.)

### WHAT VOIDS THE WARRANTY:

**Incorrect Installation:** The Performance Modules/Tuners must be installed following Quadzilla installation procedure as outlined in the product literature that accompanies the Performance Modules/Tuners. **Physical damage to the unit due to improper care in installation or removal will not be covered under this warranty.** **No Registration:** Failure to register your product within 90 days of purchase will void the one year unlimited mileage warranty. **No Proof of Purchase:** At time of warranty claim, buyer must provide proof of purchase (original receipt or invoice). **Incorrect Use:** Any damaged, abused or modified Performance Modules/Tuners will not be warranted.

### EXTENT OF WARRANTY:

Any defective Performance Modules/Tuners properly returned to QUADZILLA will be replaced or repaired by QUADZILLA. QUADZILLA will not be responsible for any other expenses incurred by the customer under the terms of this warranty, nor shall it be responsible for any damages consequential, special, contingent, or otherwise; or expenses or injury arising directly or indirectly from the use of the Performance Modules/Tuners unit or software. Any Performance Modules/Tuners returned to QUADZILLA must be sent at the customer's expense along with proof of purchase. QUADZILLA reserves the right to determine whether the terms of the warranty, set out above, have been properly complied with. In the event that the terms are not complied with, QUADZILLA shall be under no obligation to honor this warranty.

### SHORTAGES AND DAMAGED GOODS:

It is the responsibility of the customer to inspect and count products upon receipt. Any shortages or errors must be reported to Quadzilla immediately. Claims for shortages or damaged goods must be received within 3 days of receipt of the product. All merchandise is inspected before packing. Any damaged goods should be reported to the freight carrier immediately. All packaging of damaged goods must be kept for inspection by the freight carrier.

### RETURNS AND EXCHANGES:

An RMA (return merchandise authorization) must accompany all returns and exchanges. Returns must include a copy of the original invoice. Returns and exchanges must be shipped pre-paid or they will be refused.

Returned or exchanged products must be undamaged, or in "like new" condition. Damage occurred during freight due to improper packing is the responsibility of the customer.

Unauthorized or refused merchandise are subject to a 10% restocking fee.

**\* NOT CARB LEGAL: NOT FOR SALE OR USE IN CALIFORNIA & CARB STATES.**

## DISCLAIMER

### **THIS IS A HIGH PERFORMANCE PRODUCT. USE AT YOUR OWN RISK**

Do not use this product until you have carefully read the following agreement.

This sets forth the terms and conditions for the use of this product. The installation of this product indicates that the BUYER has read and understands this agreement and accepts the terms and conditions.

### **DISCLAIMER OF LIABILITY**

Quadzilla Power, LLC and its distributors, jobbers and dealers (hereafter SELLER) shall in no way be responsible for the product's proper use and service. THE BUYER HEREBY WAIVES ALL LIABILITY CLAIMS.

The BUYER acknowledges that he/she is not relying on the SELLER's skill or judgment to select or furnish goods suitable for any particular purpose and that there are no liabilities which extend beyond the description on the face hereof and the BUYER hereby waives all remedies or liabilities, expressed or implied arising by law or otherwise, (including without any obligations of the SELLER with respect to fitness, merchantability and consequential damages) or whether or not occasioned by the SELLER's negligence.

The SELLER disclaims any warranty and expressly disclaims any liability for personal injury or damages. The BUYER acknowledges and agrees that the disclaimer of any liability for personal injury is a material term for this agreement and the BUYER agrees to indemnify the SELLER and to hold the SELLER harmless from any claim related to the item of the equipment purchased. Under no circumstances will the SELLER be liable for any damages or expenses by reason of use or sales of such equipment.

The SELLER assumes no liability regarding the improper installation or misapplication of its products. It is the installer's responsibility to check for proper installation and if in doubt, contact the manufacturer.

### **LIMITATION OF WARRANTY**

Quadzilla Power, LLC (hereafter "SELLER") gives limited warranty as to description, quality, merchantability, fitness for any product's purpose, productiveness, or any other matter of SELLER's product herewith. The SELLER shall be in no way responsible for the product's open use and service and the BUYER hereby waives all rights other than those expressly written herein. This warranty shall not be extended or varied in, except by a written instrument signed by SELLER and BUYER.

The warranty is limited to one (1) year from the date of sale and limited solely to the parts contained within the product's kit. All products that are in question of Warranty must be returned shipping prepaid to the SELLER and must be accompanied by a dated proof of purchase receipt. All warranty claims are subject to approval by Quadzilla Power, LLC.

Under no circumstances shall the SELLER be liable for any labor charged or travel time incurred in diagnosis for defects, removal, or reinstallation of this product, or any other contingent expenses.

Under no circumstances shall the SELLER be liable for any damages or expenses insured by reason of the use of sale of any such equipment.

**IN THE EVENT THAT THE BUYER DOES NOT AGREE WITH THIS AGREEMENT: THE BUYER MAY PROMPTLY RETURN THIS PRODUCT, IN A NEW AND UNUSED CONDITION WITH A DATED PROOF OF PURCHASE TO THE PLACE OF PURCHASE WITHIN THIRTY (30) DAYS FROM THE DATE OF PURCHASE FOR A FULL REFUND.**

**THE INSTALLATION OF THIS PRODUCT INDICATES THAT THE BUYER HAS READ AND UNDERSTANDS THIS AGREEMENT AND ACCEPTS ITS TERMS AND CONDITIONS.**

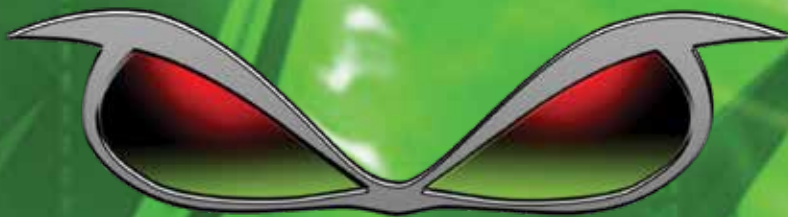

# QUADZILLA POWER

3072 N 750 EAST  
LAYTON, UT 84041  
1-801-872-5472

[WWW.QUADZILLAPOWER.COM](http://WWW.QUADZILLAPOWER.COM)

Go to our website for the latest version of instructions.  
<http://www.quadzillapower.com/installation-intructions/>

